

(REVISED COURSE)

(3 Hours)

[Total Marks : ~~100~~
80

- N.B. (1) Question No. 1 is compulsory.
(2) Attempt any three questions from remaining five questions.
(3) Assume suitable data if required.

1. (a) Find forces P and Q such that resultant of given system is zero. 4

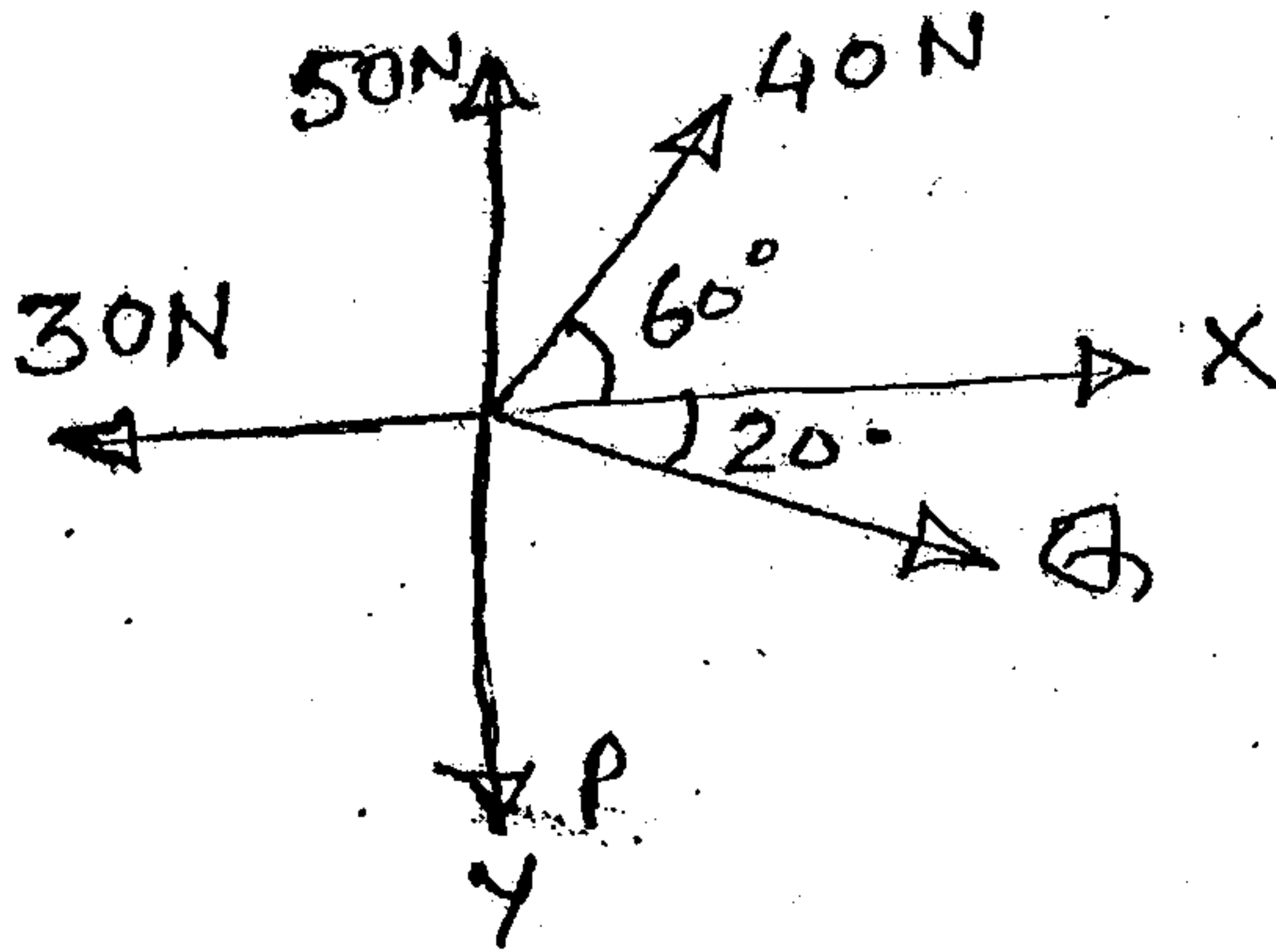

(b) A cylinder B, $W_B = 1000\text{ N}$, dia. 40 cm, hangs by a cable AB = 40 cm rests against a smooth wall. 4

Find out reaction at C and ~~W~~ T_{AB} .

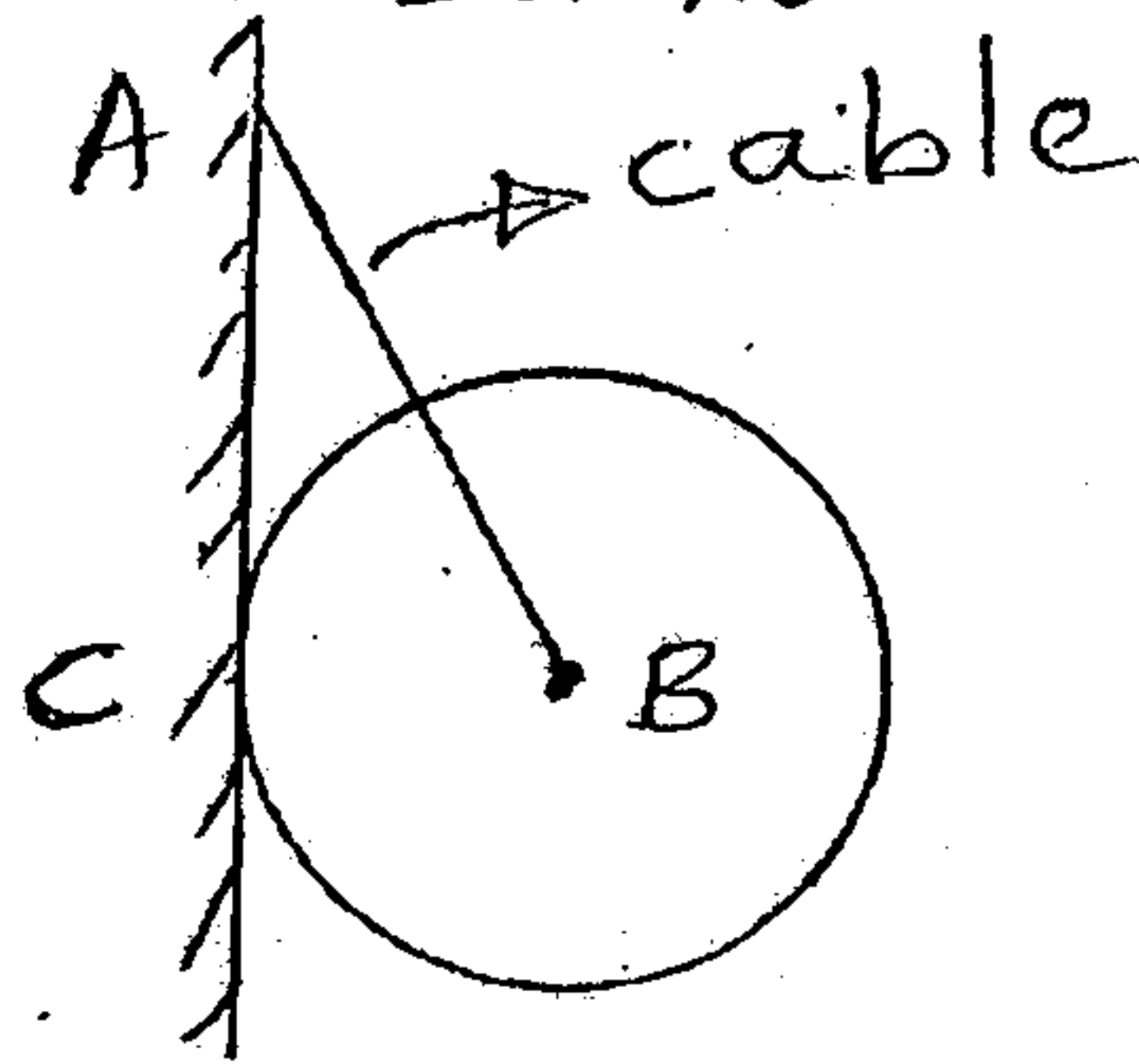

(c) A block of weight 1000 N is kept on a rough inclined surface. Find out range of P for which the block will be in equilibrium. 4

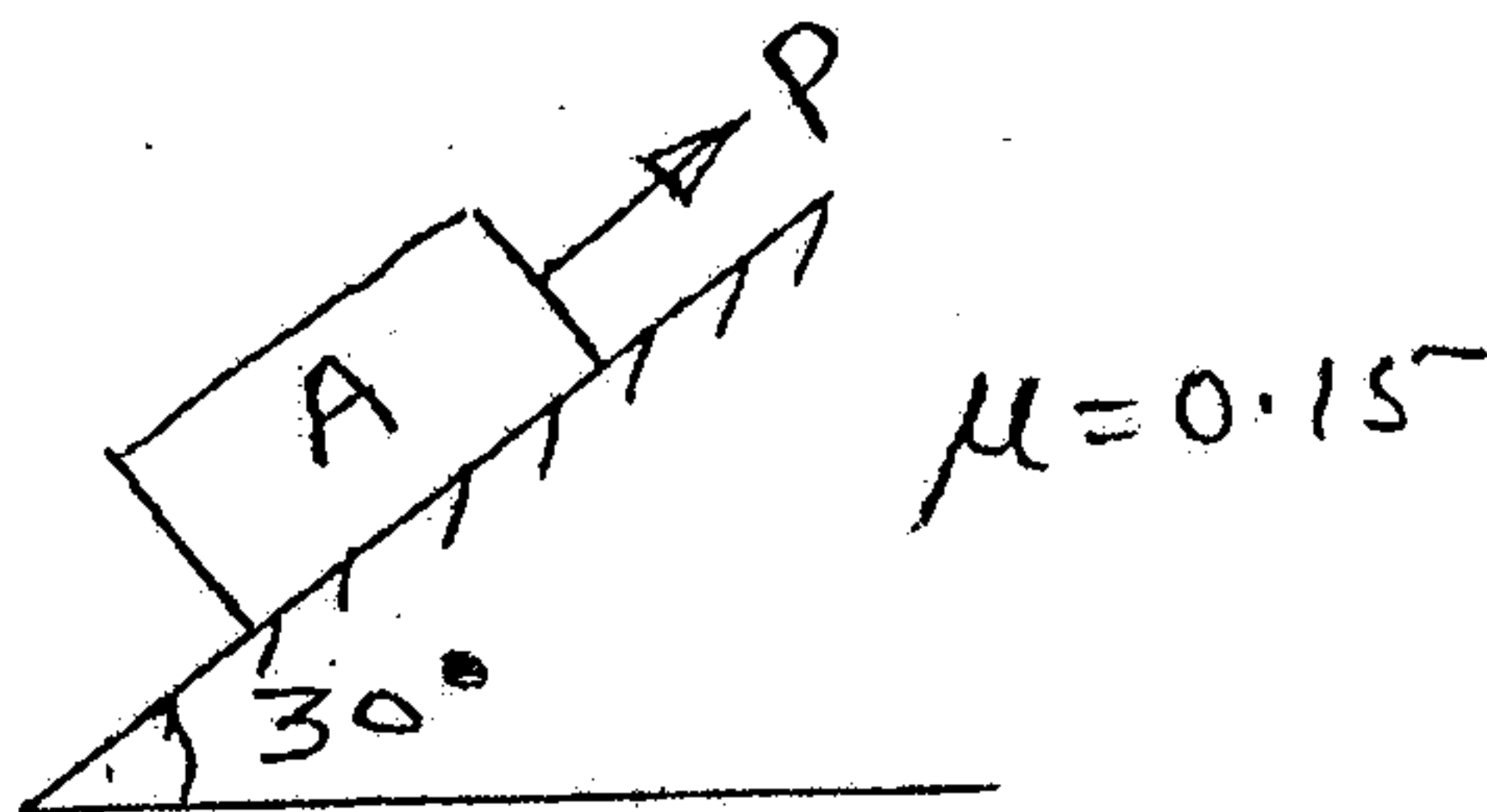

www.campuskeeda.com

www.campuskeeda.com

[TURN OVER

- (d) A curvilinear motion of a particle is defined by $v_x = 25 - 8t$ m/s and $y = 48 - 3t^2$ m. At $t = 0$, $x = 0$. Find out position, velocity and acceleration at $t = 4$ sec. 4
- (e) State D'Alembert's principle with two examples. 4
2. (a) Find out resultant of given (lever) force system w.r.t. "B". 6

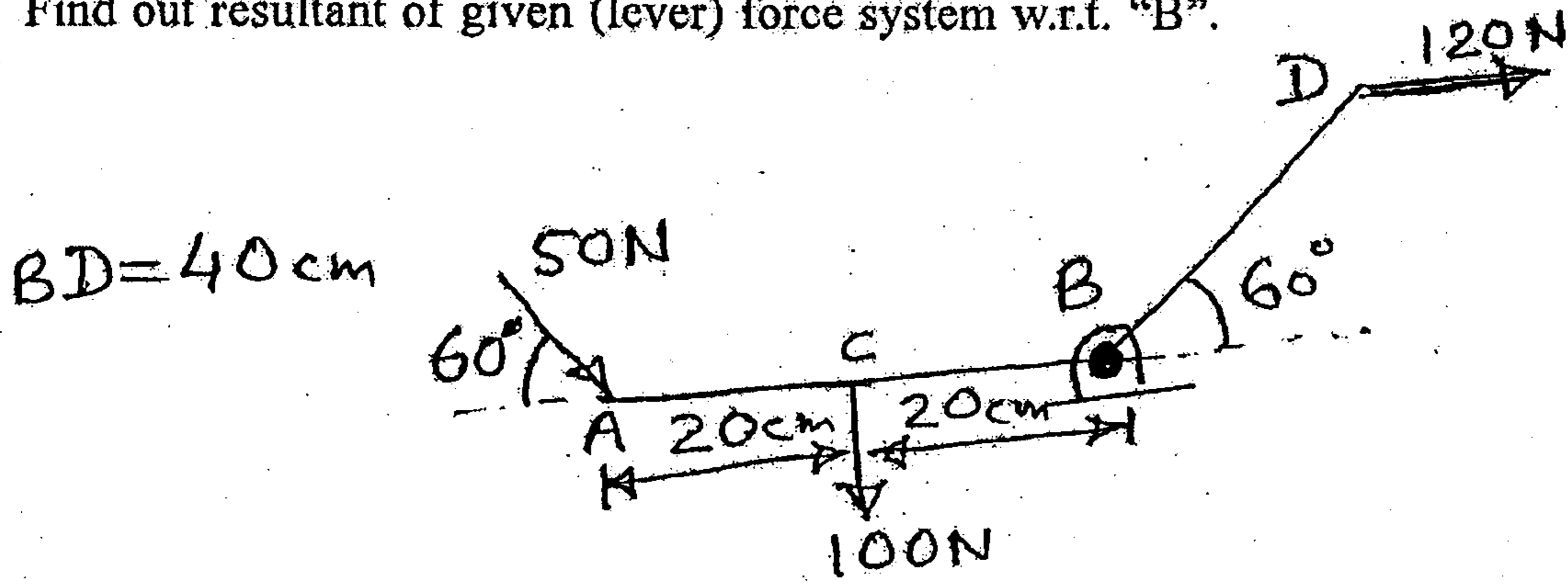

- (b) Two identical cylinders dia 100 mm weight 200 N are placed as shown. All contacts are smooth. Find out reactions at A, B and C. 8

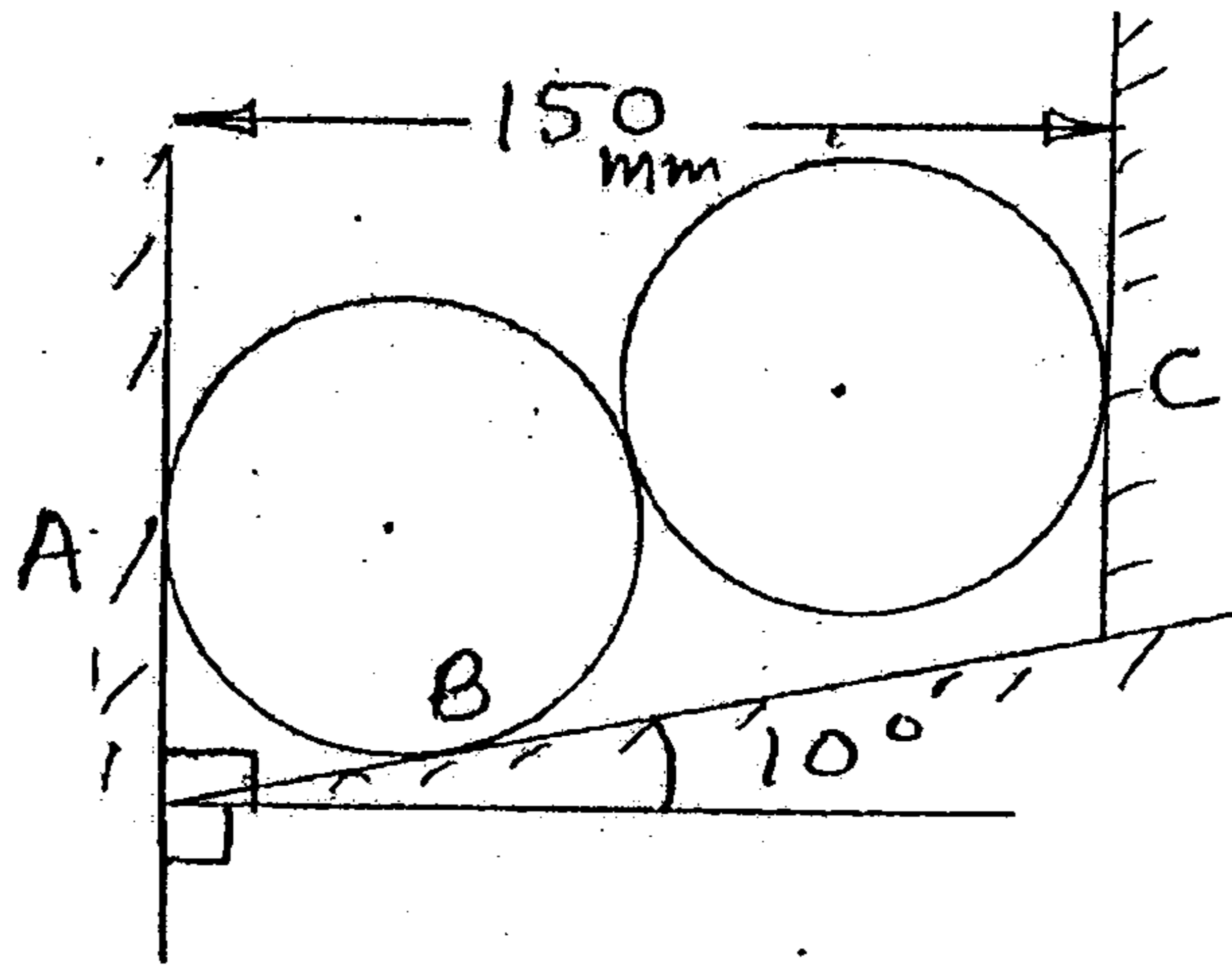

- (c) A ball of mass m kg hits an inclined smooth surface with a velocity $V_A = 3$ m/s. Find out velocity of rebound. 6

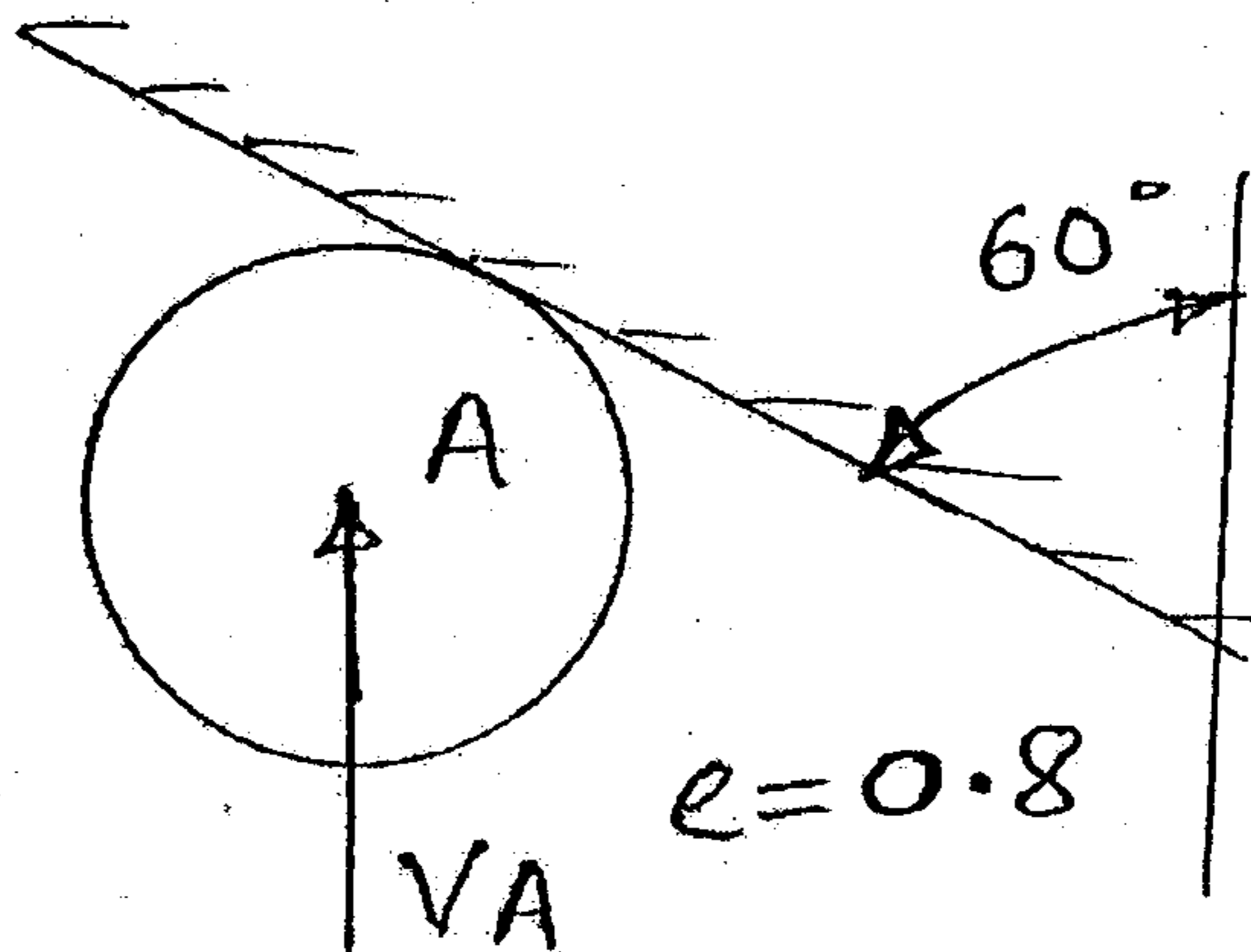

3. (a) Find centroid of the shaded area.

8

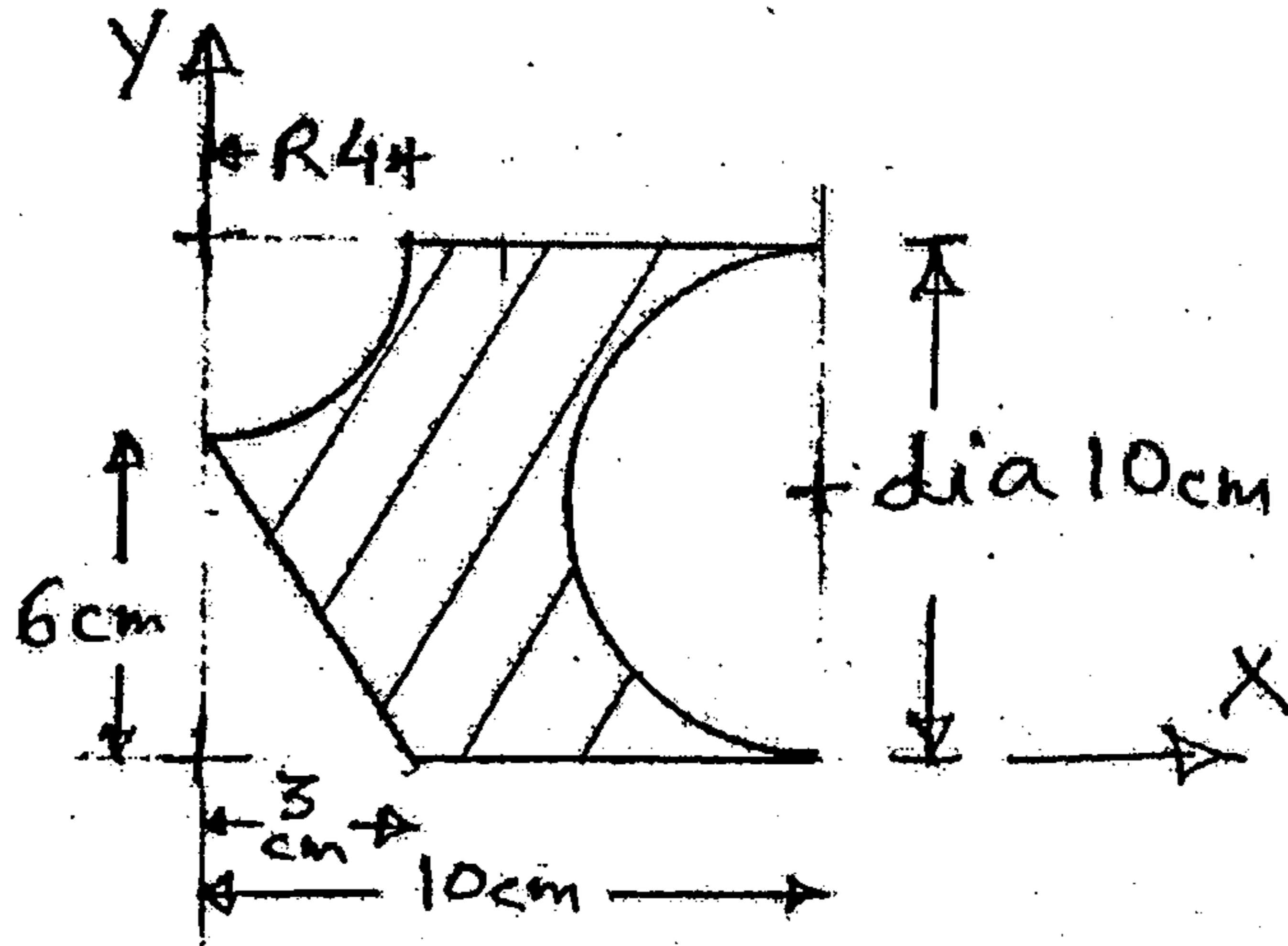

(b) Explain conditions for equilibrium for forces in space.

6

(c) Explain work energy principle.

6

4. (a)

8

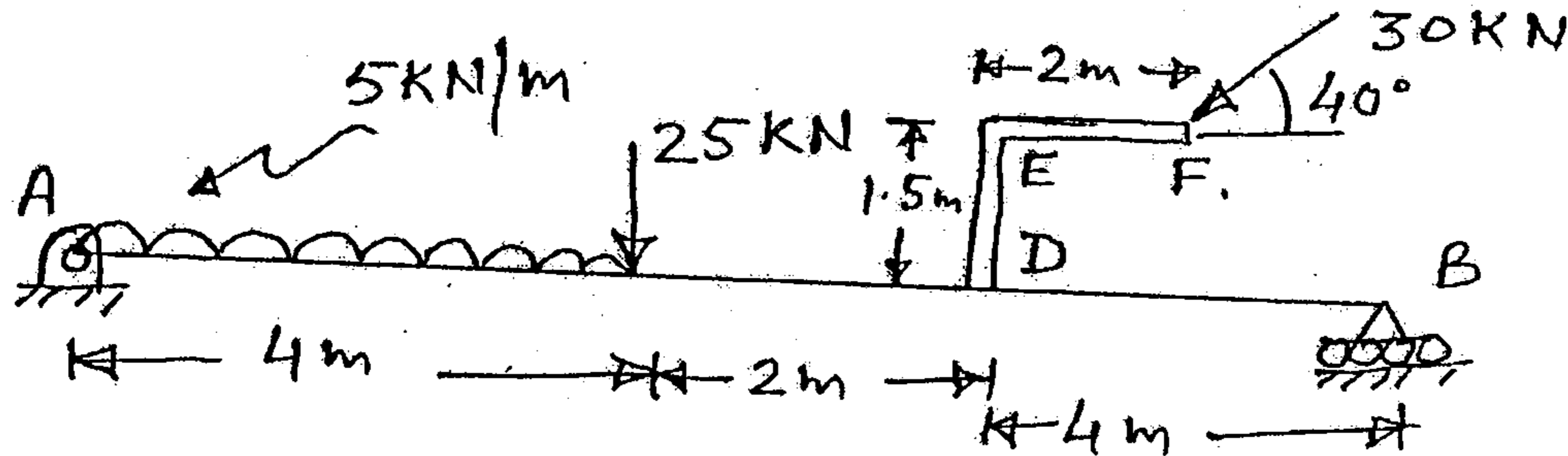

Find the support reactions at Hinge A and Roller B.

6

(b) Explain x-t, v-t and a-t curves in Kinematics.

6

(c) Collar B moves up with constant velocity $V_B = 2 \text{ m/s}$. Rod AB is pinned at B.

Find out angular velocity of AB and velocity of A.

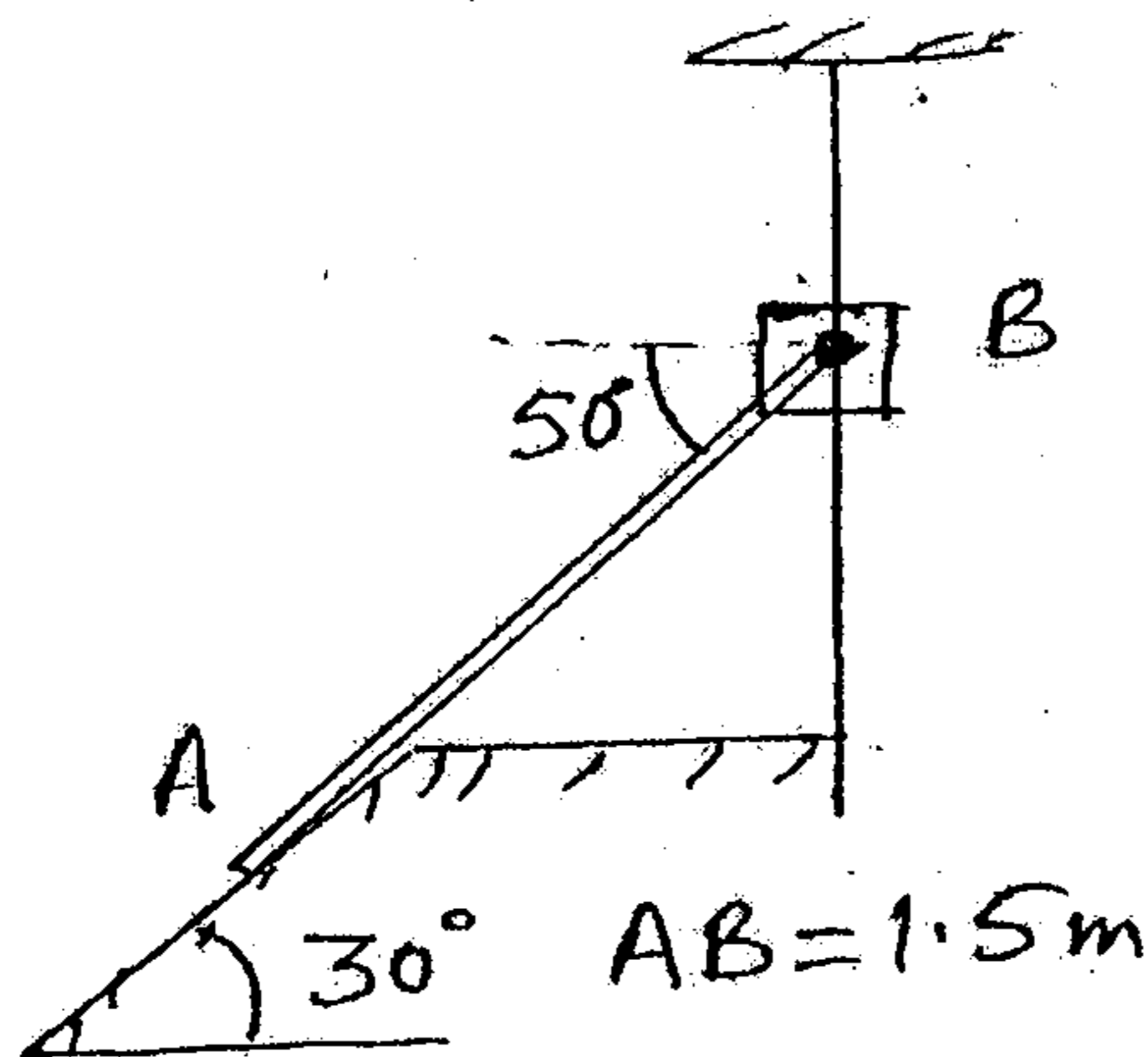

[TURN OVER

5. (a) Find out forces in FB and BE using method of section and other members by method of joints. 8

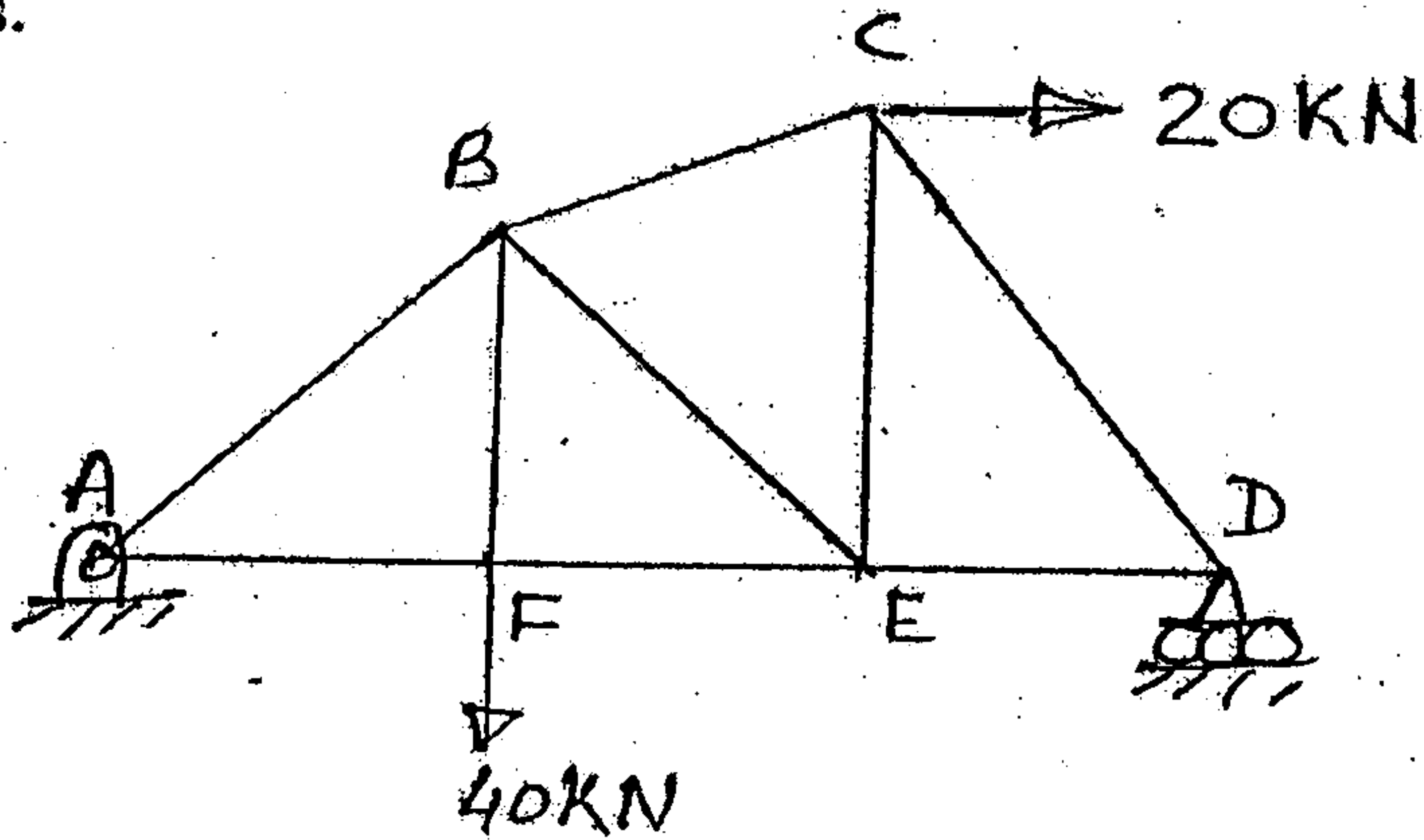

$AF = FB = FE = ED = 2\text{m}$
 $CE = 3\text{m}$

- (b) A stone is thrown vertically upwards and returns to the starting point at the ground in 6 sec. Find out max. height and initial velocity of stone. 6
- (c) Explain instantaneous centre of rotation. 6
6. (a) Force $F = (3i - 4j + 12k)\text{N}$ acts at point A (1, -2, 3). Find — 4
- (i) Moment of force about origin
- (ii) Moment of force about point B(2, 1, 2)m.
- (b) Find out min. value of P to start the motion. 8

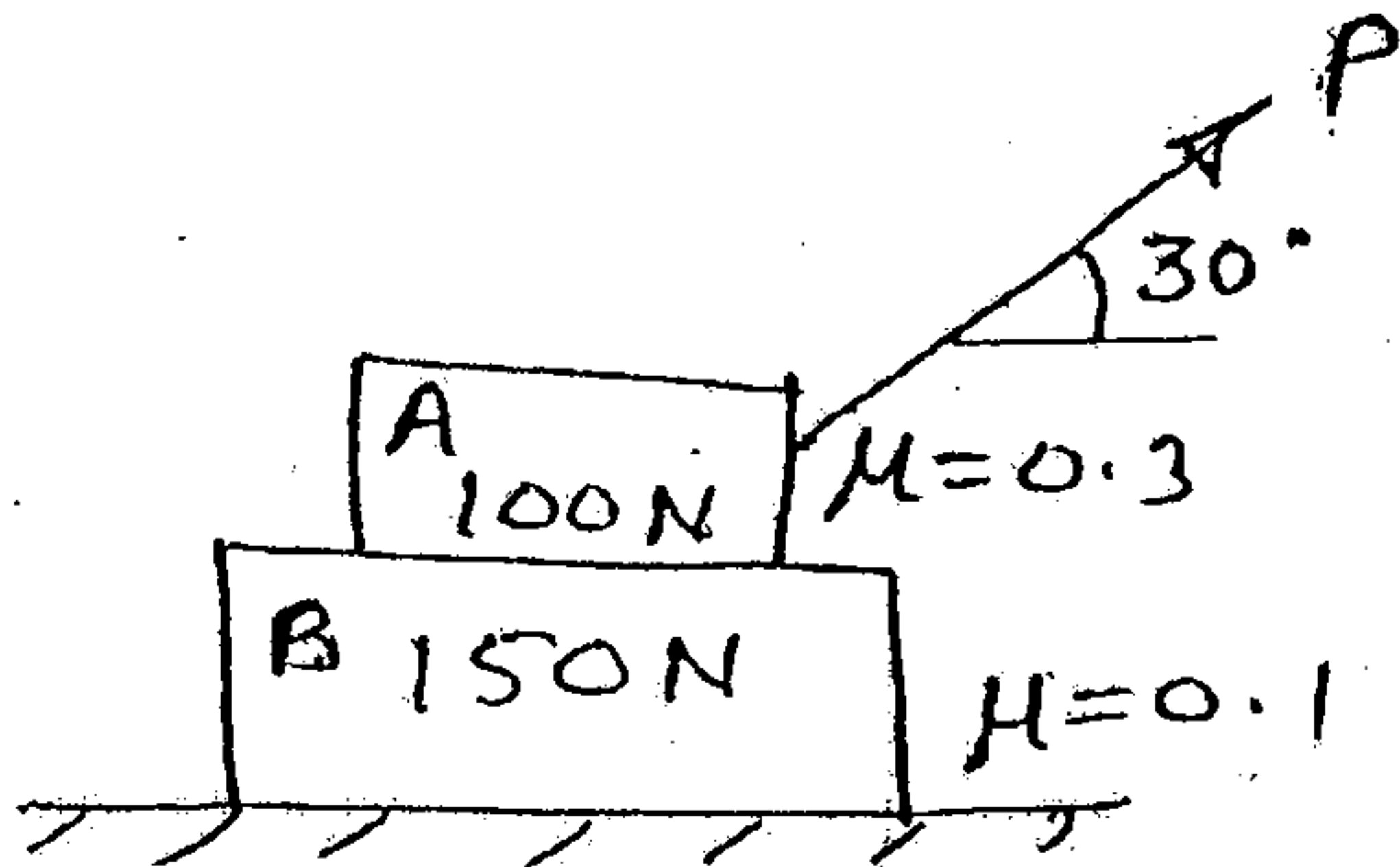

- (c) For a particle in rectilinear motion $a = -0.05 v^2 \text{ m/s}^2$, at $v = 20 \text{ m/s}$, $x = 0$. Find x at $v = 15 \text{ m/s}$ and acc^n at $x = 50 \text{ m}$. 4
- (d) Sphere A is supported by two wires AB, AC. Find out tension in wire AC :— 4
- (i) before AB is cut
- (ii) just after AB is cut.

